

294/950 EF

Dimensions

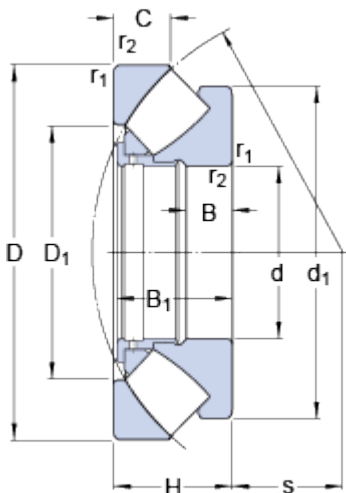

d	950	mm
D	1600	mm
H	390	mm
d ₁	≈ 1470	mm
D ₁	≈ 1209	mm
B	153	mm
B ₁	377	mm
C	191	mm
s	546	mm
r _{1,2}	min. 15	mm

Abutment dimensions

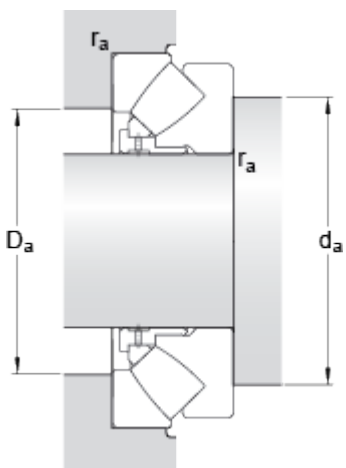

d _a	min. 1275	mm
D _a	max. 1400	mm
r _a	max. 12	mm

Calculation data

Basic dynamic load rating	C	28200	kN
Basic static load rating	C ₀	132000	kN
Fatigue load limit	P _u	7800	kN
Reference speed		140	r/min
Limiting speed		280	r/min
Minimum axial load factor	A	1700	

Mass

Mass bearing		3065	kg
--------------	--	------	----